

Comparison of computed frequency responses of intrinsic and encapsulated bead type thermocouples in liquid sodium

L. KREBS

Kernforschungszentrum Karlsruhe, Institut für Reaktorbauelemente, Postfach 3640,
D-7500 Karlsruhe, F.R.G.

and

K. BREMHORST

University of Queensland, Department of Mechanical Engineering, St. Lucia Qld. 4067, Australia

(Received 2 November 1983 and in final form 1 February 1986)

Abstract—A comparative, theoretical study of intrinsic and conventional sheathed, beaded thermocouple frequency responses has been carried out for a limited range of heat impulses in order to highlight differences in their responses for measurements in liquid sodium flows such as are met in exit plenums of nuclear reactor sub-assemblies. The mathematical model consists of a thin impulse layer surrounding the thermocouple, all of which is immersed in a pool of sodium. Only axisymmetric cases are considered for ease of computation but different positions and thicknesses of the impulse layer are included in the study. In the range of normally occurring frequencies of temperature fluctuations in the exit plenum of reactor sub-assemblies, the intrinsic thermocouple is seen to have almost a perfect response but only if the heated layer is in contact with the wire attachment point of the couple. This is attributed to the fact that sodium surrounding the thermocouple and impulse layer dominates the heat diffusion due to its very high thermal conductivity. The sheathed, beaded thermocouple has a poor frequency response even in the range of normally occurring frequencies.

INTRODUCTION

INTEREST exists in the measurement of temperature fluctuations in the exit plenum of sodium cooled fast breeder reactor core sub-assemblies. From spectral and statistical analyses of these fluctuations it is hoped to be able to quickly detect local changes in coolant flow or local hot-spots. For this to be feasible, it is necessary to have a temperature sensor able to operate reliably in the hostile environment presented by the flow, as well as being able to respond to the rapid temperature fluctuations in the turbulent flow. The most suitable sensor appears to be a fast response thermocouple contained in a stainless steel sheath, or an intrinsic thermocouple for which the time constant is ideally zero. Available evidence indicates that the energy containing part of the spectrum of temperature fluctuations extends to 100–150 Hz in such flows. Ideally, the sensor should have a flat frequency response up to at least this value thus requiring the smallest possible sensor in order to minimize thermal inertia effects. Figure 1 shows a typical commercially available three-wire thermocouple which contains an intrinsic as well as a beaded two-wire thermocouple. The latter is often considered to be the reference against which others are compared and is similar to conventional sheathed, beaded thermocouples. This arrangement permits comparison of their relative performance.

Sometimes, sheathed, two-wire thermocouples are

used where the conventional junction is bonded to the end cap in order to improve the response. Within the context of the model to be presented, this will give an identical result to the intrinsic case only if the bonding material offers negligible resistance to heat transfer and the bead has negligible thermal capacity relative to the end cap—both unlikely situations. In a practical case, a well bonded arrangement will yield results somewhere between the intrinsic case and the conventional one considered in the present analysis. However, the use of conventional beaded thermocouples bonded to the end cap without adequate electrical insulation is not favoured since leakage of sodium through the sheath in a defective end cap could not be detected readily. It is perhaps noteworthy that in the case of Fig. 1, the separation between the bead and the end cap is almost of the same dimension as for a bonded couple, where the magnesium oxide represents the bonding material. For the purpose of the analysis, magnesium oxide insulation is used but similar thermocouples using boron nitride are available. These can be expected to give a better response for the conventional thermocouple because of the higher thermal conductivity of the insulating material.

Examination of thermal flows in the three wire sensor suggests that the frequency of the intrinsic thermocouple must generally be superior to that of the beaded couple. A highly simplified analysis of the transient response of an intrinsic thermocouple attached to a flat plate subjected to a step change in

NOMENCLATURE

a, b, d, d^*, D, s	thermocouple dimensions defined in Figs 1 and 2	$ W(f) $	magnitude of frequency response function defined by equation (1)
Cr-Al	chromel-alumel thermocouple or thermocouple position	$\Phi_T(f)$	generalized symbol for spectral density of temperature response [K^2/Hz]
db	decibel = $10 \log W(f) ^2$	$\Phi_{T,Na}(f)$	spectral density of temperature response when sensor is replaced by liquid sodium [K^2/Hz]
f	frequency [Hz]	$\Phi_{T,TC}(f)$	spectral density of temperature response with sensor in position [K^2/Hz]
k	thermal conductivity		
Na-SS	sodium-stainless steel intrinsic thermocouple or thermocouple position		

plate temperature produced by a heat pulse has been presented by Henning and Parker [1], Boyer *et al.* [2], Gat *et al.* [3], and others cited in the review by Keltner and Beck [4]. Heat losses to the surroundings were neglected, or included as a simple convection loss from the thermocouple wires. Excluded from the analyses were effects due to the supporting structure of the thermocouple junction and the distributed nature of the temperature field being measured.

In liquid metal flows the thermocouple junction and its supporting structure are fully immersed in the fluid. This introduces heat flow through the fluid from the tip region to the side of the thermocouple structure.

Since previous analyses separate these two regions by an adiabatic plane, such heat flows are totally excluded. The most significant effect is that if a bulky support is required to support the thermocouple in a flow resulting in high drag forces, heat will flow from the measurement point to the support through the fluid. Presence of an adiabatic plane which separates the tip region from the flow around the support will neglect this effect.

In the present study some simplifications are made regarding the structure of the thermocouple but included are simultaneous heat exchanges between the heat impulse representing a heated lump of fluid, the thermocouple and the fluid surrounding them. No restriction is placed on the flow around the tip of the thermocouple. For simplicity of analysis and in view of the high conductivity of liquid sodium, only the case of responses in a stationary pool of fluid are considered. This yields the most pessimistic response but convection effects are not likely to improve the response significantly. Distributive effects associated with thermal e.m.f. generation are neglected which is consistent with the findings of Boyer *et al.* [2] that for a liquid sodium flow contained in a pipe of much higher electrical resistance, the measured temperature is that of a point concentrated around the wire attachment point of the intrinsic couple.

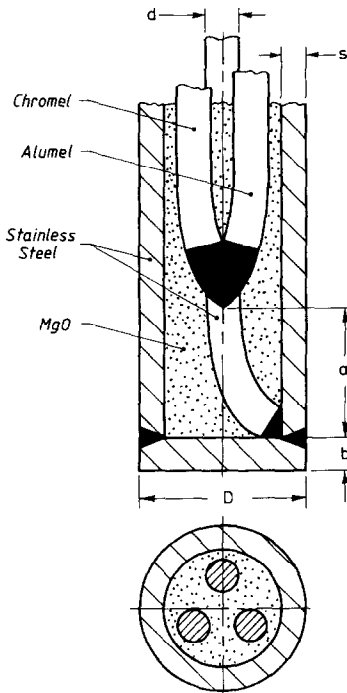

FIG 1. Structure of a typical three-wire thermocouple $D = 0.5$ mm, $d = 0.1$ mm, $a = 0.4$ mm, $b = 0.1$ mm and $s = 0.1$ mm.

MATHEMATICAL MODEL

Figure 2(a) shows the simplified geometric structure of the three wire sensor. The measurement point for the beaded thermocouple is taken to be on the centre line at distance $(a+b)$ from the tip of the sheath. To simulate an eddy, a thin layer of sodium at an initial temperature above that of the thermocouple and any surrounding fluid is placed in contact with the sheath. This is identical to impulsive heating of this layer hence giving a convenient model for frequency response studies. While the term "eddy" is a "vague term by design", Bradshaw [5], in the present context

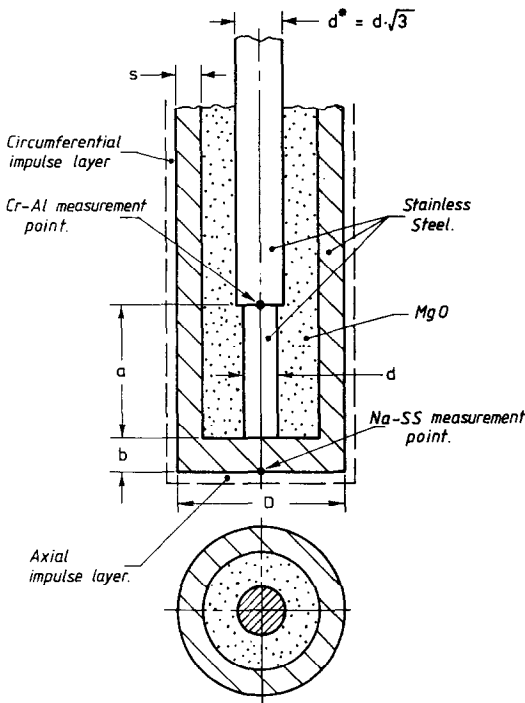

FIG. 2(a). Simplified model of three-wire thermocouple—dimensions as for Fig. 1. k of MgO = $4.4 \text{ Wm}^{-1} \text{ K}^{-1}$ and k of stainless steel = $18.6 \text{ Wm}^{-1} \text{ K}^{-1}$.

it is viewed as a reasonably coherent lump of fluid which for mathematical ease has been approximated by a cylinder into which has been inserted the measuring probe thus yielding a cylindrical layer of fluid around the sheath. This layer is termed the "impulse layer" in Fig. 2(a). Fluid surrounding the impulse layer is simulated by a pool of sodium in a cylindrical container of 20 mm dia., 70 mm depth with a thermocouple immersion depth of 50 mm along the centre line of the container and being concentric with the thermocouple, Fig. 2(b). The container and the surface of the pool of sodium are assumed adiabatic. The plane through the thermocouple where it pierces the free surface is also assumed adiabatic as otherwise a net heat loss from the system results which would prevent attainment of a steady state.

Inclusion of a more complex surrounding flow would require a knowledge of its spatial and temporal structures which are determined by the flow field to be investigated. A knowledge of such factors becomes irrelevant, however, if it can be shown that the presence of the thermocouple does not significantly influence the temperature response of an eddy at the point of measurement. Also, if the response time of the thermocouple is much shorter than that of the physical phenomenon being measured and does not introduce other stray effects such as heat conduction from the point of measurement, the output of the thermocouple will follow faithfully all fluctuations in temperature. A more effective way of viewing such a

difference is to transform the time response into the frequency domain where even small effects on the time response will show clearly. This is particularly the case when the system response becomes of higher order.

Solutions for the temperature-time response were obtained by use of the general purpose finite difference heat conduction code, HEATING5, described fully by Turner *et al.* [6]. A cylindrical coordinate formulation was specified for geometric details and the Crank-Nicolson procedure was employed for numerical solution of the transient finite difference equations. In order to obtain adequate spatial resolution and still retain reasonable solution times, a variable mesh size grid was employed, Fig. 2(c). The resultant time responses were then Fourier transformed thus giving the spectral response to an impulse heat input. Since after suitable scaling the Fourier transform of an impulse function is unity, the scaled spectral responses are proportional to the square of the frequency response function of the thermocouple.

In the present context, this is not a particularly meaningful result. A frequency dependent impulse response function for the measurement positions of the intrinsic and beaded thermocouples would still be obtained even if the thermocouple were not present but, instead, were replaced by the working fluid. That is, due to the effect of surrounding fluid, a heat impulse input to the impulse layer would not result in a step function for the temperature of the impulse layer as was the case in Henning and Parker [1]. The temperature input function of interest is, in fact, the impulse response when the thermocouple has been

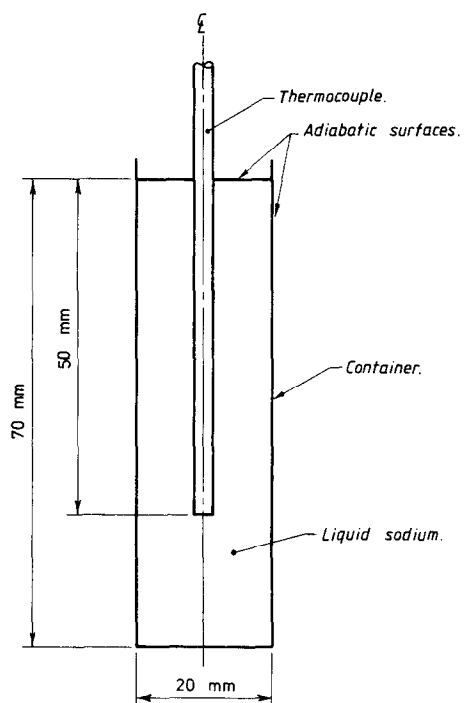

FIG. 2(b). Geometric arrangement of the thermocouple in a liquid sodium container.

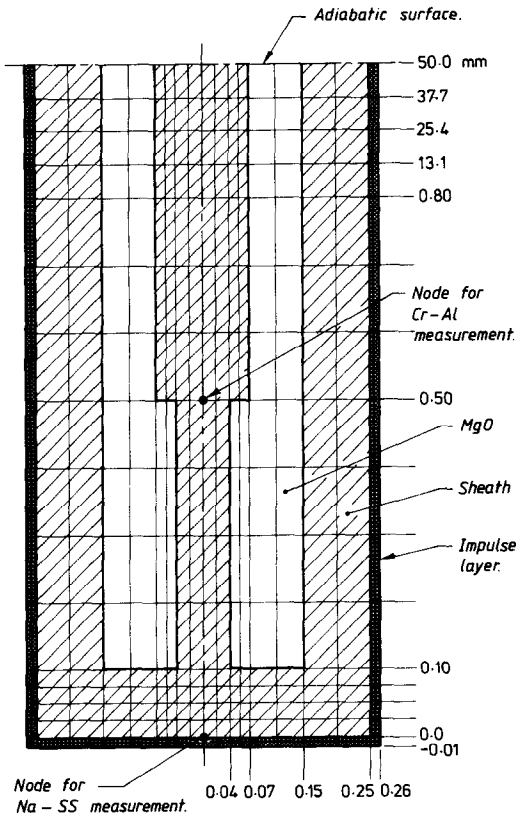

FIG. 2(c). Finite difference grid details used for the thermocouple depicted in Fig. 2(a).

replaced by working fluid but assuming that the eddy containing the heat impulse—in this case the thin layer surrounding the original thermocouple sheath—retains its shape rather than becoming a cylindrical or spherical element. The justification for this approach is that if the impulse response is insensitive to a gross change of thermal sensor material, the response must be dominated by conduction effects in the fluid rather than through the sensor. The square of the thermocouple frequency response function is then given by equation (1).

$$|W(f)|^2 = \frac{\Phi_{T,TC}(f)}{\Phi_{T,Na}(f)}, \quad (1)$$

where $\Phi_{T,TC}(f)$ is the temperature spectrum as obtained from the heat impulse response with the thermocouple in position and $\Phi_{T,Na}(f)$ is the temperature spectrum as obtained from the heat impulse response when the sensor is replaced by liquid sodium. $\Phi_{T,Na}(f)$ is considered to be the input spectrum for the actual transducer whereas $\Phi_{T,TC}(f)$ is its output spectrum.

RESULTS

Calculations were performed for heat impulses by giving the impulse layer (liquid sodium) an initial temperature of 300°C, irrespective of its thickness or

shape. Any surrounding fluid (also liquid sodium) and the thermocouple were given an initial temperature of 200°C. A time step of 2×10^{-5} s was used as it was found that further decreases in step size left the solutions unchanged. Total response time was limited to 0.3 s to save computation time. Only every fourth time step was used in the subsequent Fourier transform so that spectral results are limited to the range of 3.33 Hz to 6.25 kHz which should be adequate since typical temperature spectra in the exit plenum of a liquid metal cooled nuclear reactor would be well below 1 kHz.

Any limitation introduced into the results by the finite solution time is immaterial if the transducer approaches the ideal response or if only comparative results are required in order to establish how significantly the response deviates from the ideal. Some indication of truncation is, however, available from the shape of the spectral curve in the low frequency range. If the curve shows a constant value with decreasing frequency, no truncation has occurred.

The effect on the temperature spectrum of a change in thickness of the impulse layer is significant, Figs. 3(a) and (b). At both measurement positions, in the absence of the thermocouple, $\phi_{T,Na}(f)$ curves, the trend towards a saddle (flat region or dip) is clearly visible for the thicker layer, Fig. 3(a). This is typical of the response obtained from the interaction of two dominant and well separated time constants and is similar to a two-lump heat-capacity system as analysed in Kreith [7] or Holman [8]. The same effect is noted in Fig. 3(a) for the intrinsic thermocouple (Na-SS position) when the sensor is in position but it is no longer evident at the Cr-Al position because of the large thermal inertia associated with the sensor.

Comparison of impulse responses obtained with and without the sensor in the sodium pool, Figs. 3(a) and (b), indicates that the Na-SS position response is independent of whether or not the sensor is in position thus giving $|W(f)| = 1.0$ within the range of the results shown. Gross distortions are, however, obtained at the Cr-Al positions. The frequency response obtained is shown in Fig. 4. As the impulse layer thickness increases, the frequency response at low frequencies improves at the Cr-Al position but this does not extend to the higher frequencies.

Another useful situation is the response obtained when the impulse layer thickness varies around the sensor, Fig 5(a). Comparison of this with the uniform impulse layer thickness of Figs. 3(a) and (b) show this to be between the 0.01 and 0.1 mm cases. Again, the Na-SS thermocouple gives a near perfect response, Fig. 5(b), but the Cr-Al thermocouple is limited in frequency response. A small departure from unity for the frequency response of the intrinsic thermocouple is noted in this instance but is insignificant compared with the rapid drop-off of the beaded couple. The results of Figs. 4 and 5(b) indicate, therefore, that provided the heated impulse layer is in contact with the Na-SS position, a near perfect response is

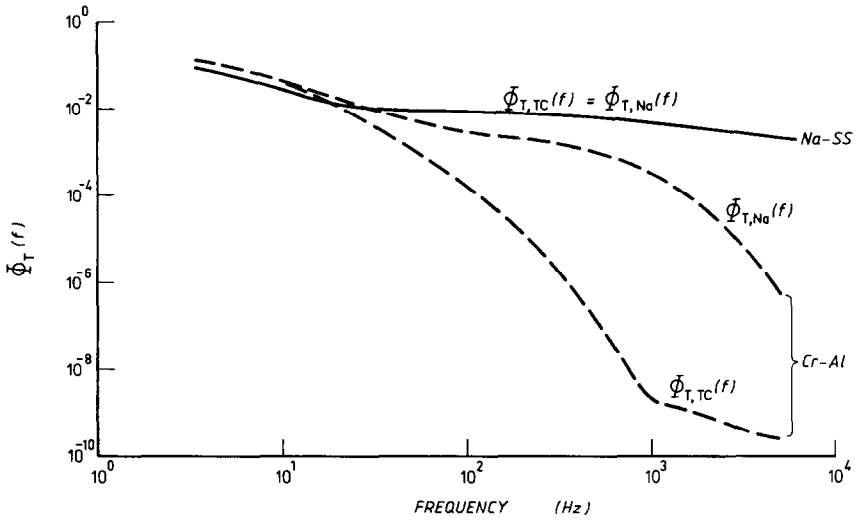

FIG. 3(a). Impulse responses with axial and circumferential impulse layers of 0.1 mm thickness in sodium pool.

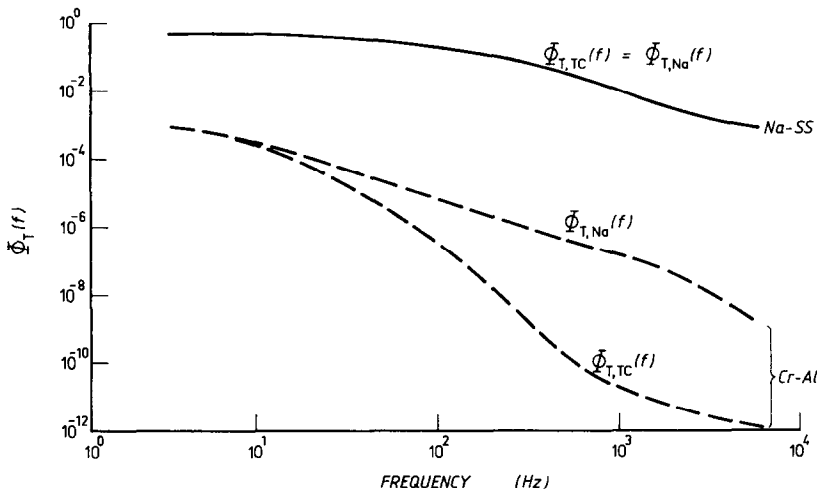

FIG. 3(b). As for Fig. 3(a) but with impulse layer thickness of 0.01 mm.

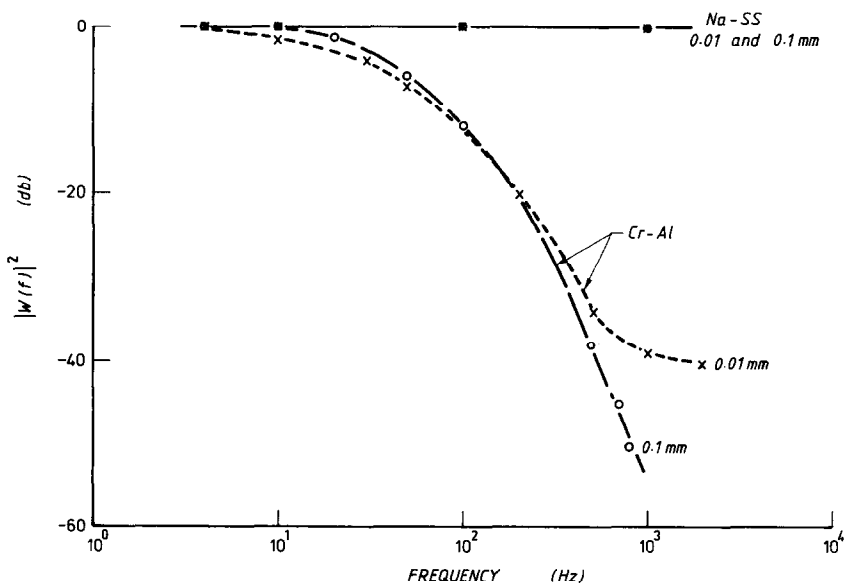

FIG. 4. Sensor frequency response for the intrinsic and beaded thermocouples determined from data of Figs. 3(a) and (b).

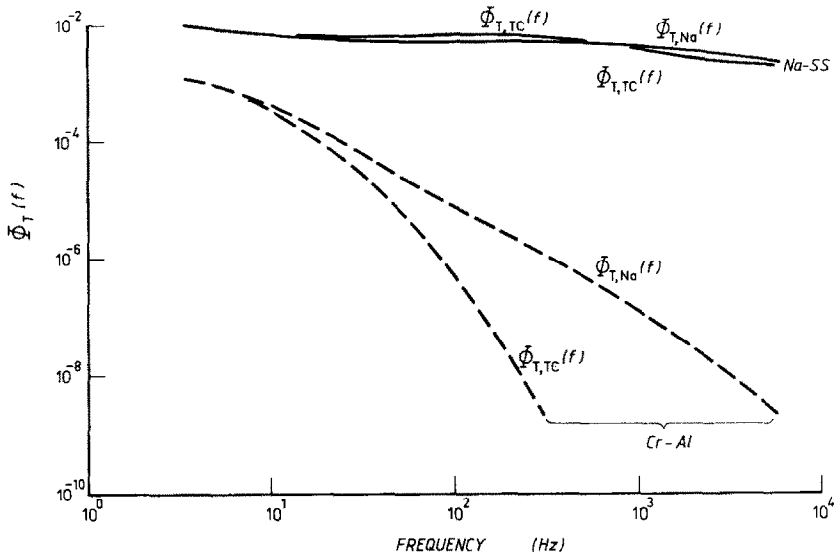

FIG. 5(a). Impulse responses with sensor in sodium pool—impulse layer thickness: 0.01 mm circumferentially and 0.1 mm axially.

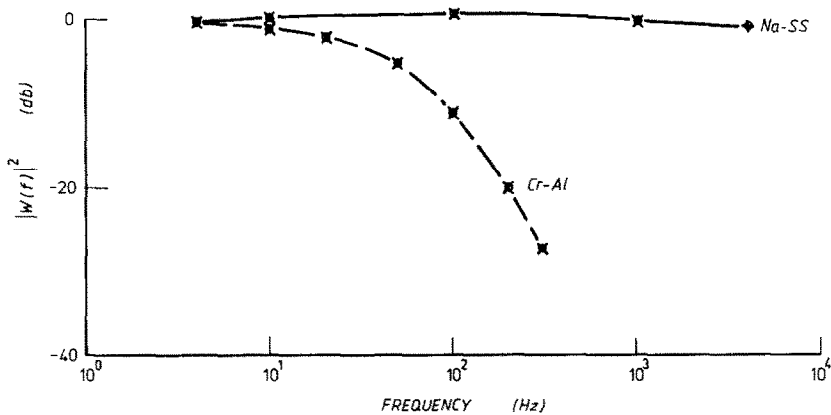

FIG. 5(b). Sensor frequency response for the intrinsic and beaded thermocouple for case of Fig. 5(a).

obtained for the intrinsic thermocouple thus indicating that surrounding fluid dominates heat flow from the impulse layer, but the beaded one has significant attenuation even at quite low frequencies. Furthermore, the frequency response of the two thermocouples appears to be almost independent of the thickness of the impulse layer and its distribution.

When the impulse layer is not in contact with the Na-SS position, an output is still obtained from the intrinsic thermocouple due to conduction along the surrounding fluid and the thermocouple support system. Since the frequency response function is near unity for frequencies up to only approximately 80 Hz, Fig. 6, this means that temperatures at the Na-SS position are measured reasonably accurately up to this frequency. Above this point a significant effect on response occurs which would introduce uncertainties

into a measurement. It is noteworthy that if the tip and the sides of the thermal sensor were separated by an adiabatic plane as is traditionally the case, Keltner [4], a much slower response would be obtained since the only heat flow to the Na-SS measurement point would be through the thermal sensor. In such a case, the thermal conductivity of the latter would dominate rather than the fluid thermal conductivity. The Cr-Al thermocouple response is, however, only marginally affected. This case shows that the support system of the thermocouple leads to a significant spatial effect for the intrinsic measurement point.

Responses in the absence of the pool of sodium are shown in Figs. 7(a) and (b). In this case all heat is conducted from the impulse layer to the thermocouple so that its thermal conductivity will dominate the response. As expected, even the Na-SS position

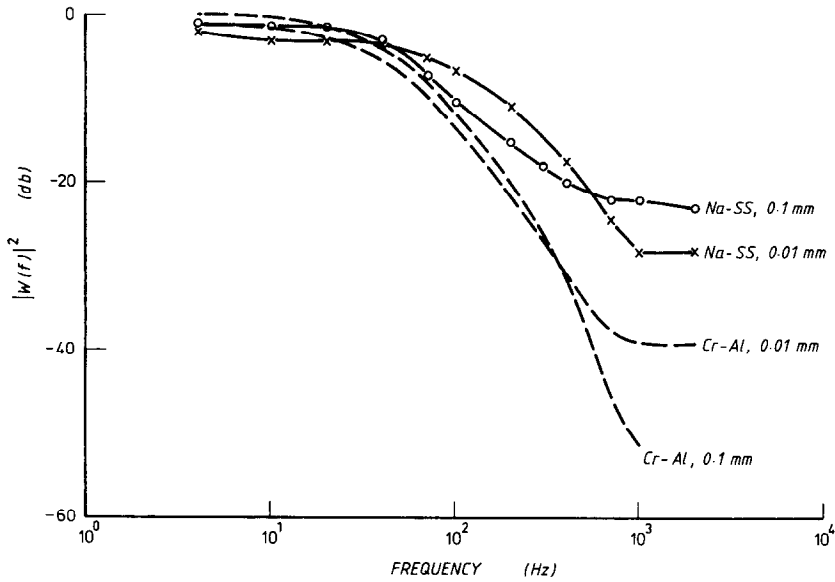

FIG. 6. Sensor frequency response with sensor in sodium pool but only a circumferential impulse layer of thickness shown.

response is dependent on the material in the space occupied by the sensor since the heat flow path through the surrounding fluid is no longer present. For both thicknesses of the impulse layer, spectral values at low frequencies are lower when sodium replaces the sensor which is attributed to the higher thermal conductivity of the sodium, but the high frequency response is improved. It is of interest to note the trend towards a weak resonance in the response at the Cr-Al position with the sensor in position. This arises because of a second but much smaller rise in the time response. The first rise is due to the heat conducted radially which has a shorter path from the impulse layer than that conducted from the tip of the sensor. When sodium replaces the sensor, the second rise occurs much sooner due to the higher thermal conductivity. A corresponding move of the spectral

peak to higher frequencies is expected. This is visible for the thicker impulse layer case, Fig. 7(a) but is hidden by other effects for the thin layer case of Fig. 7(b). The net result is that even the intrinsic thermocouple has a distorted frequency response with $|W(f)| \neq 1.0$, Fig. 7(c).

The case of no pool of sodium and an impulse layer only at the tip of the sensor is given in Fig. 8. In this case the intrinsic thermocouple departs from the ideal response even at low frequencies. This is due to the insulating effect of the sensor. Extension of the analysis to still lower frequencies showed both frequency responses to attain a constant value with decreasing frequency, as is to be expected. The significance of this case is again that the intrinsic thermocouple will not give a perfect response under all conditions.

A simple check of the computer program is afforded

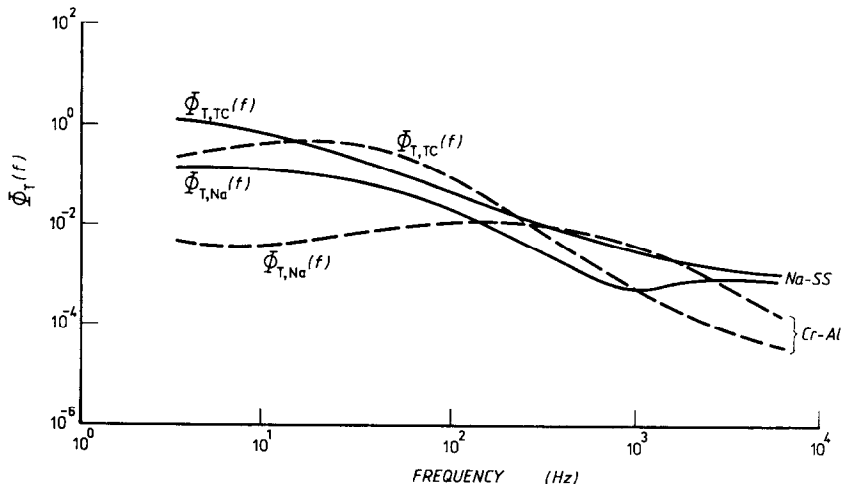

FIG. 7(a). Impulse responses in absence of sodium pool—axial and circumferential impulse layer thickness of 0.1 mm.

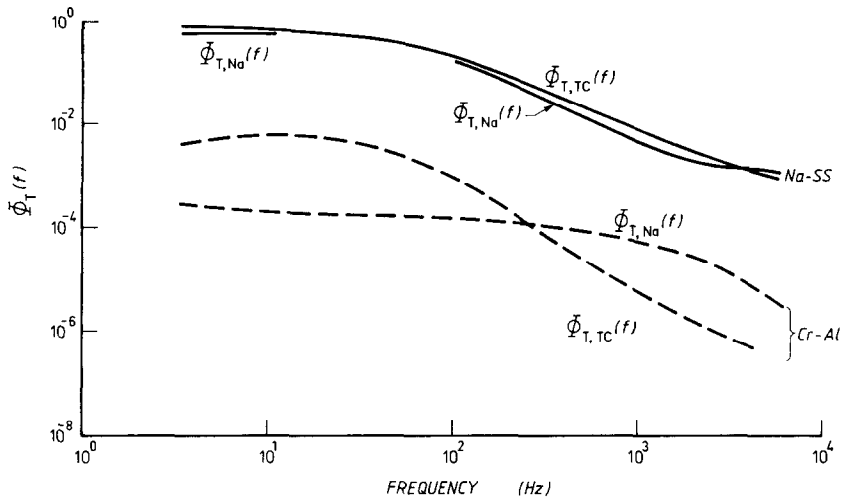

FIG. 7(b). As for Fig. 7(a) but impulse layer of 0.01 mm.

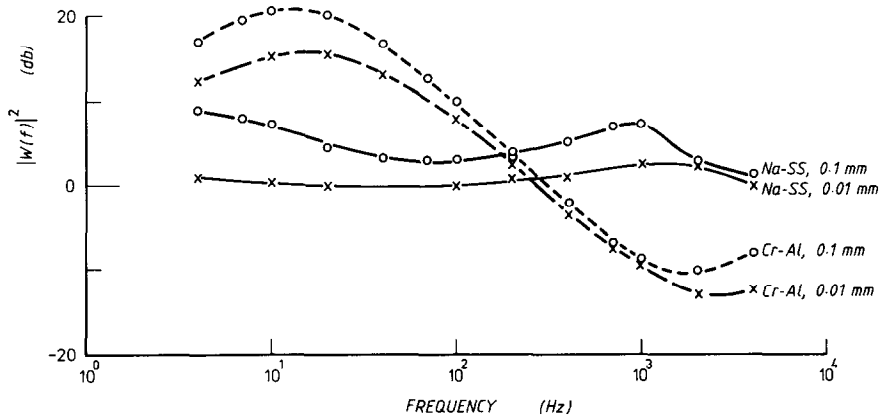

FIG. 7(c). Sensor frequency response for intrinsic and beaded thermocouple in absence of sodium pool, data as for Figs. 7(a) and (b).

by the case of no sodium pool and only a circumferential impulse layer with the Na-SS position being on an adiabatic surface. For the case with the sensor replaced by sodium, the Na-SS and Cr-Al positions should give identical responses. This was indeed the case.

CONCLUDING REMARKS

A model has been presented of a typical thermocouple sensor available for measurements in liquid sodium. Only no-flow conditions have been studied but due to the high thermal conductivity of liquid sodium, convection effects will be small. Since convection effects increase heat transfer coefficients, the present results give the most pessimistic solution. Thus, provided that the frequency response function is unity and that associated with these frequencies are spatial scales larger than the transducer size, a correct

measurement of temperature will be obtained. The modelling does not use simplifying assumptions in the region of contact of the intrinsic thermocouple and does not restrict heat flow around the tip of the sensor to or from its sides as was the case in previous studies, but in order to retain axisymmetry, structural simplifications within the sensor were used.

Results presented for a 0.5 mm dia. beaded and sheathed chromel-alumel thermocouple clearly show the very limited frequency response achievable in liquid sodium flows. As long as the heated fluid, the temperature of which is to be measured, is in contact with the intrinsic thermocouple measuring point, the intrinsic thermocouple will give an undistorted measurement to at least 3–4 kHz. If such coincidence does not exist, the frequency response becomes very limited.

Although the geometry and constructional details of the sheathed thermocouple in the present study and

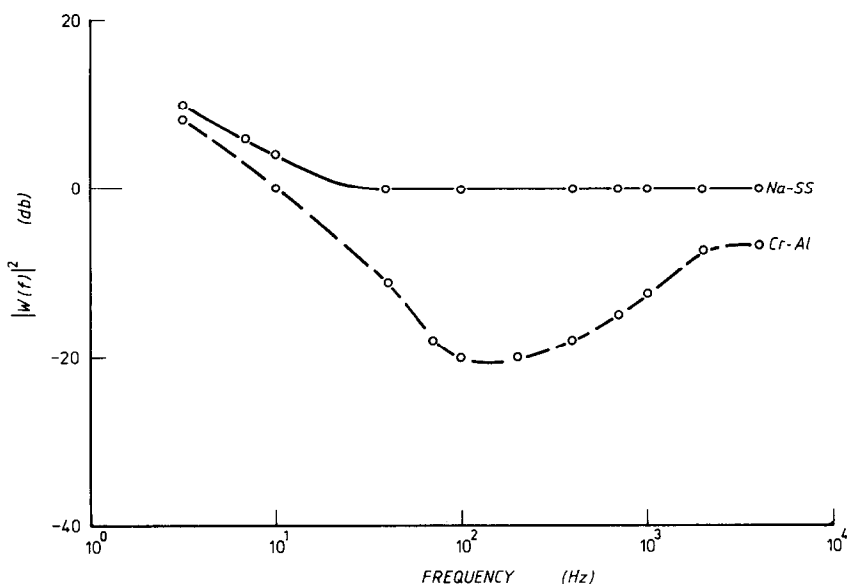

FIG. 8. Sensor frequency response in absence of sodium pool with an axial impulse layer of 0.1 mm thickness.

the ideal intrinsic thermocouple studied by Keltner and Beck [4], are quite different, it is of interest to note that the -3 db point of the latter yields a frequency range of up to 1 or 28 kHz depending on whether the overall sheath diameter or just the wire diameter is taken as relevant. Considerations by Boyer *et al.* [2] indicate that the effective diameter is closer to the wire diameter so that the higher estimate of effective frequency range is relevant. This estimate would be consistent with results of Fig. 4.

For practical applications, the present results indicate that provided a continuum of fluid exists around the thermal sensor, the intrinsic thermocouple considered gives a near perfect response to only approximately 80 Hz. The main limitation is introduced by the condition where fluid of different temperature to that at the tip—intrinsic thermocouple measuring point—is in contact with the remainder of the probe structure. Ideally, therefore, a practical sensor should be of insulating material throughout except for the actual measuring point. Situations where the spatial extent of the fluid is small relative to the sensor size is found to lead to a highly distorted response which does not permit simple correction.

Application in a turbulent flow, requires that the frequency response be adequate for the application as well as that the spatial scale of the temperature fluctuations or eddies be large relative to the sensor dimensions since the present model assumes that the sensor is fully immersed within the eddy. This is not a particularly severe restriction since measurements by Krebs *et al.* [9] in a water simulation of a reactor flow found temperature scales, both macro and micro, to be larger than the sensor under consideration. For example, for a multi-bore jet block with bores of 7.2

mm dia., the temperature micro- and macro-scale in the downstream flow exceeded 1.0 mm. When changing to a highly conductive fluid, the length scales will increase approximately as the inverse square root of the Prandtl number thus reducing the possible spatial resolution problem considerably. Application of such a sensor in a practical nuclear reactor will lead to a negligible spatial resolution effect since length scales will be even larger relative to the sensor size. Clearly, a sensor of this type is suitable for dissipation scale measurements only in large scale flows. This is not a serious limitation as only the energy containing range is usually of interest.

Experimental verification of the computed results is, however, difficult due to the rapid response of the intrinsic thermocouple. Dipping of such a sensor into a pool of sodium would have to be much faster than the initial response of the thermocouple. Indications are that experimental verification of the computed results will probably have to await the development of an ingenious pulse heating technique which heats only the impulse layer—a difficult task when the sensor itself is conductive and embedded in the fluid.

Acknowledgement—The authors are indebted to Professor U. Müller for making this joint research possible and also for his continued encouragement.

REFERENCES

1. C. D. Henning and R. Parker, Transient response of an intrinsic thermocouple, *J. Heat. Transfer, Trans. ASME* **89**, 146–154 (1967).
2. J. Boyer, E. Cambillard and J. Heutz, Probeless temperature measurements at the wall of a liquid–metal flow. *Progress in Heat and Mass Transfer*, Vol. 7, pp. 75–79. Pergamon Press, Oxford (1973).

3. U. Gat, D. S. Kammer and O. J. Hahn, The effect of temperature dependent properties on transient measurement with intrinsic thermocouple, *Int. J. Heat Mass Transfer* **18**, 1337–1342 (1975).
4. N. R. Keltner, and J. V. Beck, Surface temperature measurement errors, *J. Heat Transfer, Trans. ASME* **105**, 312–318, May (1983).
5. P. Bradshaw, *An Introduction to Turbulence and its Measurement*. Pergamon Press, Oxford (1971).
6. W. D. Turner, D. C. Elrod and I. I. Siman-Tov, HEA-ING5—an IBM 360 heat conduction program, Computer Sciences Division, Union Carbide Corp., Nuclear Division (ORNL/CSD/TM-15) (1977).
7. F. Kreith, *Principles of Heat Transfer*. Intext, New York (1973).
8. J. P. Holman, *Heat Transfer*. McGraw-Hill, New York (1981).
9. L. Krebs, K. Bremhorst and U. Müller, Measurements of thermal diffusion downstream of a multi-bore jet block, *Lecture Notes in Physics*, Vol. 76, *Structure and Mechanisms of Turbulence II* (edited by H. Fiedler). Springer, Berlin (1977).

COMPARAISON DES REPONSES FREQUENTIELLES CALCULEES DE THERMOCOUPLES SIMPLES ET DE TYPE ENCAPSULE AVEC DES PERLES, PLACES DANS DU SODIUM LIQUIDE

Résumé—Une étude théorique et comparative des réponses fréquentielles de thermocouples simples, ou blindés, avec des perles, est conduite pour un domaine limité d'impulsions thermiques de façon à dégager des différences dans leurs réponses pour des mesures dans les écoulements de sodium liquide comme on en rencontre dans les plenums de sortie des sous-ensembles de réacteur nucléaire. Le modèle mathématique consiste en une couche mince entourant le thermocouple, immergé dans un bain de sodium. On considère uniquement des cas axisymétriques par facilité de calcul mais différentes positions et épaisseurs de la couche sont incluses dans l'étude. Dans le domaine des fréquences normales de fluctuations de température, le thermocouple intrinsèque a une réponse plutôt parfaite mais seulement si la couche chauffée est en contact avec le point d'attache du fil du couple. Ceci est attribué au fait que le sodium entourant le thermocouple et la couche domine la diffusion thermique, à cause de sa très grande conductivité thermique. Le thermocouple gainé, avec des perles, a une faible réponse en fréquence même dans le domaine des fréquences rencontrées en pratique.

VERGLEICH DES BERECHNETEN ZEITVERHALTENS VON FREIEN UND UMMANTELTEN KUGELFÖRMIGEN THERMOELEMENTEN IN FLÜSSIGEM NATRIUM

Zusammenfassung—Es wurde eine theoretische Vergleichsuntersuchung über das Zeitverhalten freier und konventionell ummantelter, kugelförmiger Thermolemente für einen begrenzten Bereich von Wärmepulsen durchgeführt, um Unterschiede in ihrem Verhalten bei Messungen in Strömungen von flüssigem Natrium herauszustellen, wie sie am Austritts-Plenum bei Kernreaktoren auftreten. Das mathematische Modell enthält eine dünne Impulsschicht, welche das Thermolement umgibt; beide sind in einen Behälter mit Natrium eingetaucht. Wegen der einfacheren Berechnung werden nur achsensymmetrische Fälle behandelt. Es werden aber unterschiedliche Positionen und Dicken der Impulsschicht betrachtet. Im Bereich der normalen Frequenzen der Temperaturschwankungen im Austritts-Plenum von Reaktoruntereinheiten zeigt das freie Thermolement ein fast perfektes Verhalten, aber nur wenn die beheizte Schicht den Drahtberührungspunkt des Thermolements berührt. Das ummantelte kugelförmige Thermolement hat ein schlechtes Zeitverhalten, gerade im Bereich der normalerweise auftretenden Frequenzen.

СРАВНЕНИЕ РАССЧИТАННЫХ ЧАСТОТНЫХ ХАРАКТЕРИСТИК ТЕРМОПАР С ОТКРЫТЫМ СПАЕМ И ЗАДЕЛАННЫМ В ОБОЛОЧКУ В ЖИДКОМ НАТРИИ

Аннотация—Проведено сравнительное теоретическое изучение частотных характеристик термопар с открытым спаем и заделанных в оболочку для некоторого диапазона тепловых импульсов для определения различий в их характеристиках при измерениях в потоках жидкого натрия, имеющих в областях повышенного давления на выходе подсистем ядерного реактора. Математическая модель включает в рассмотрение импульсный слой, окружающий термопару, полностью погруженную в объем натрия. Для упрощения счета рассматриваются только осесимметричные случаи, хотя исследовались различные положения и толщины импульсного слоя. В обычном диапазоне частот температурных флуктуаций в области повышенного давления подсистем реактора видно, что термопара с открытым спаем имеет почти идеальную характеристику, но лишь когда нагреваемый слой соприкасается с точкой присоединения проволочек термопары. Это связано с тем, что перенос тепла в натрии, окружающем термопару и импульсный слой, является определяющим из-за высокой теплопроводности. Термопара с заделанным в оболочку спаем имеет неудовлетворительную частотную характеристику даже в обычном диапазоне частот.